

Memorex[®]

MT1120S

SERVICE MANUAL

COLOR TELEVISION RECEIVER

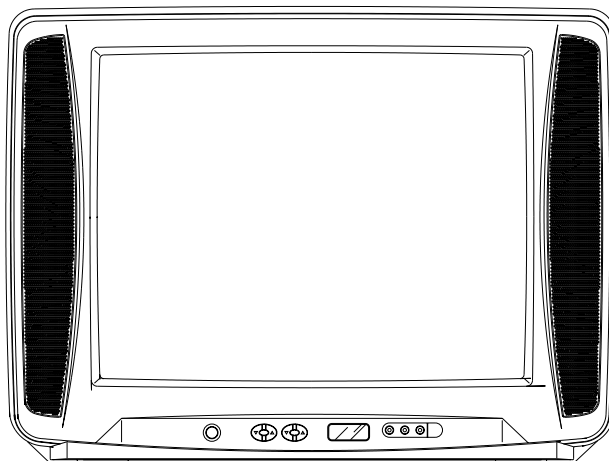

**ORIGINAL
MFR'S VERSION E**

PRINTED CIRCUIT BOARDS
MAIN/CRT (CHIP MOUNTED PARTS)
SOLDER SIDE

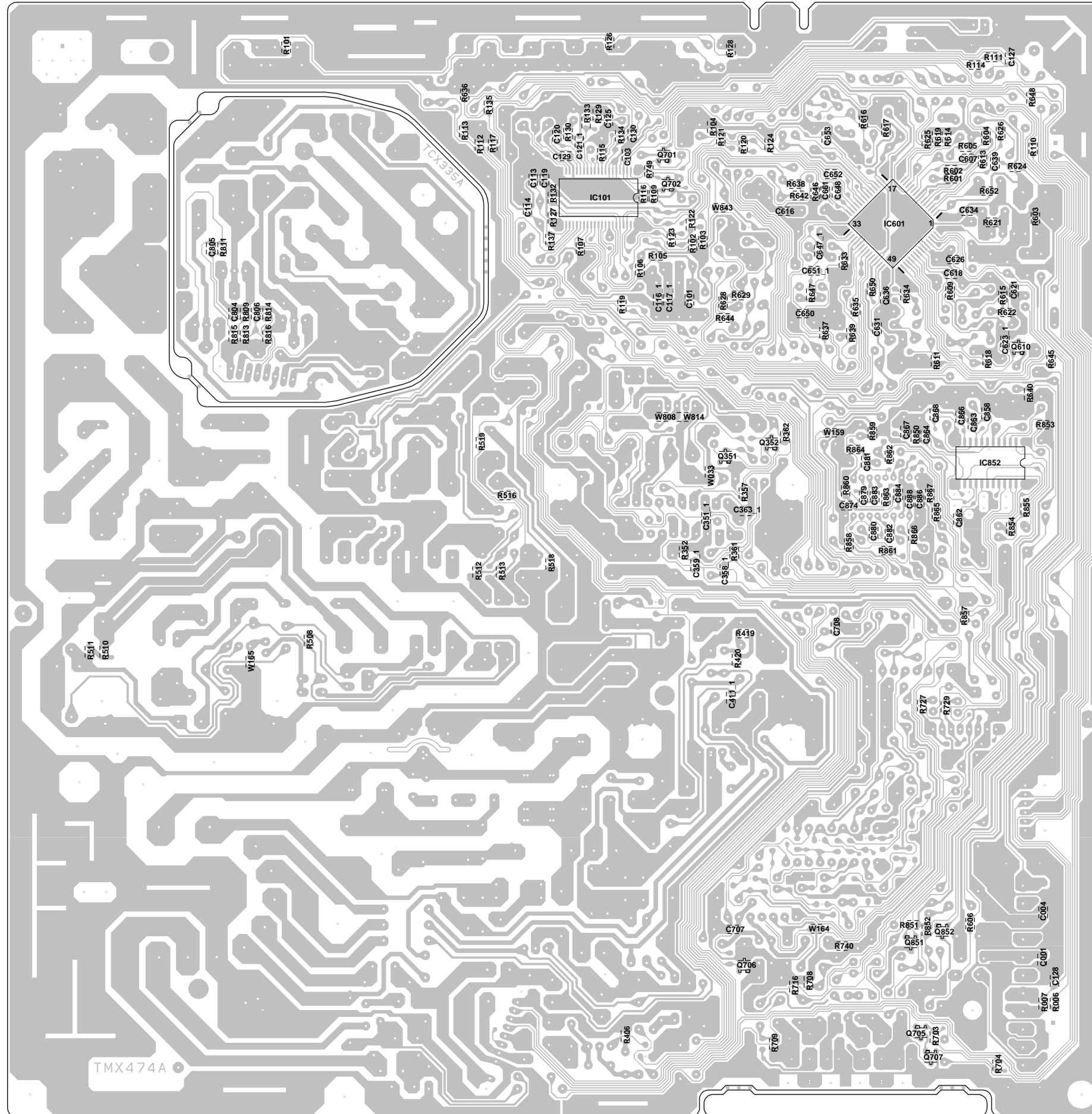

MICON/TUNER SCHEMATIC DIAGRAM (MAIN PCB)

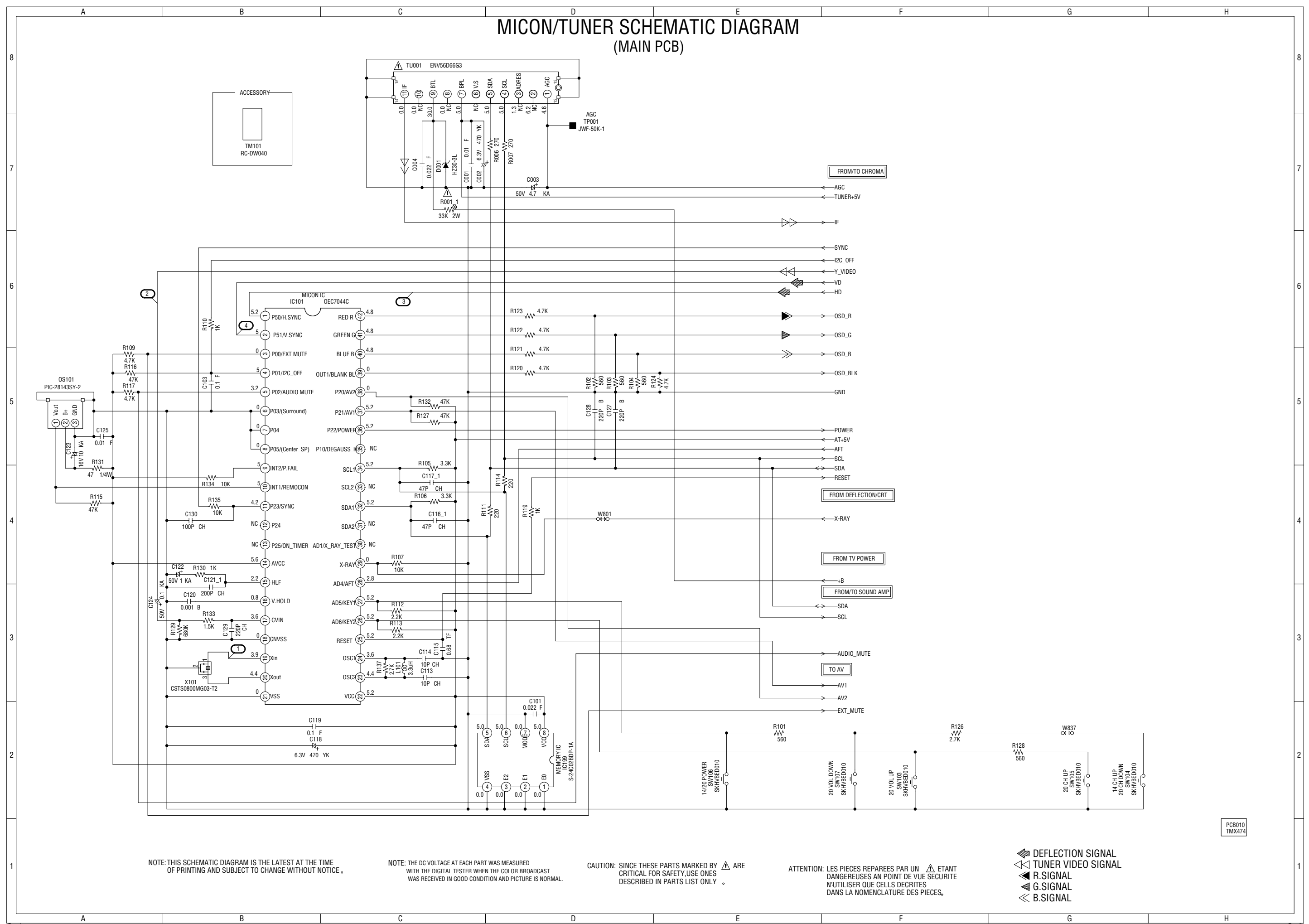

NOTE: THIS SCHEMATIC DIAGRAM IS THE LATEST AT THE TIME OF PRINTING AND SUBJECT TO CHANGE WITHOUT NOTICE.

NOTE: THE DC VOLTAGE AT EACH PART WAS MEASURED WITH THE DIGITAL TESTER WHEN THE COLOR BROADCAST WAS RECEIVED IN GOOD CONDITION AND PICTURE IS NORMAL.

CAUTION: SINCE THESE PARTS MARKED BY ARE CRITICAL FOR SAFETY USE ONES DESCRIBED IN PARTS LIST ONLY.

ATTENTION: LES PIÈCES REPARÉES PAR UN ÉTANT DANGEREUSES AN POINT DE VUE SECURITE N'UTILISER QUE CELLES DECRITES DANS LA NOMENCLATURE DES PIÈCES.

- DEFLECTION SIGNAL
- TUNER VIDEO SIGNAL
- R.SIGNAL
- G.SIGNAL
- B.SIGNAL

PCB010
TMX474

CHROMA SCHEMATIC DIAGRAM (MAIN PCB)

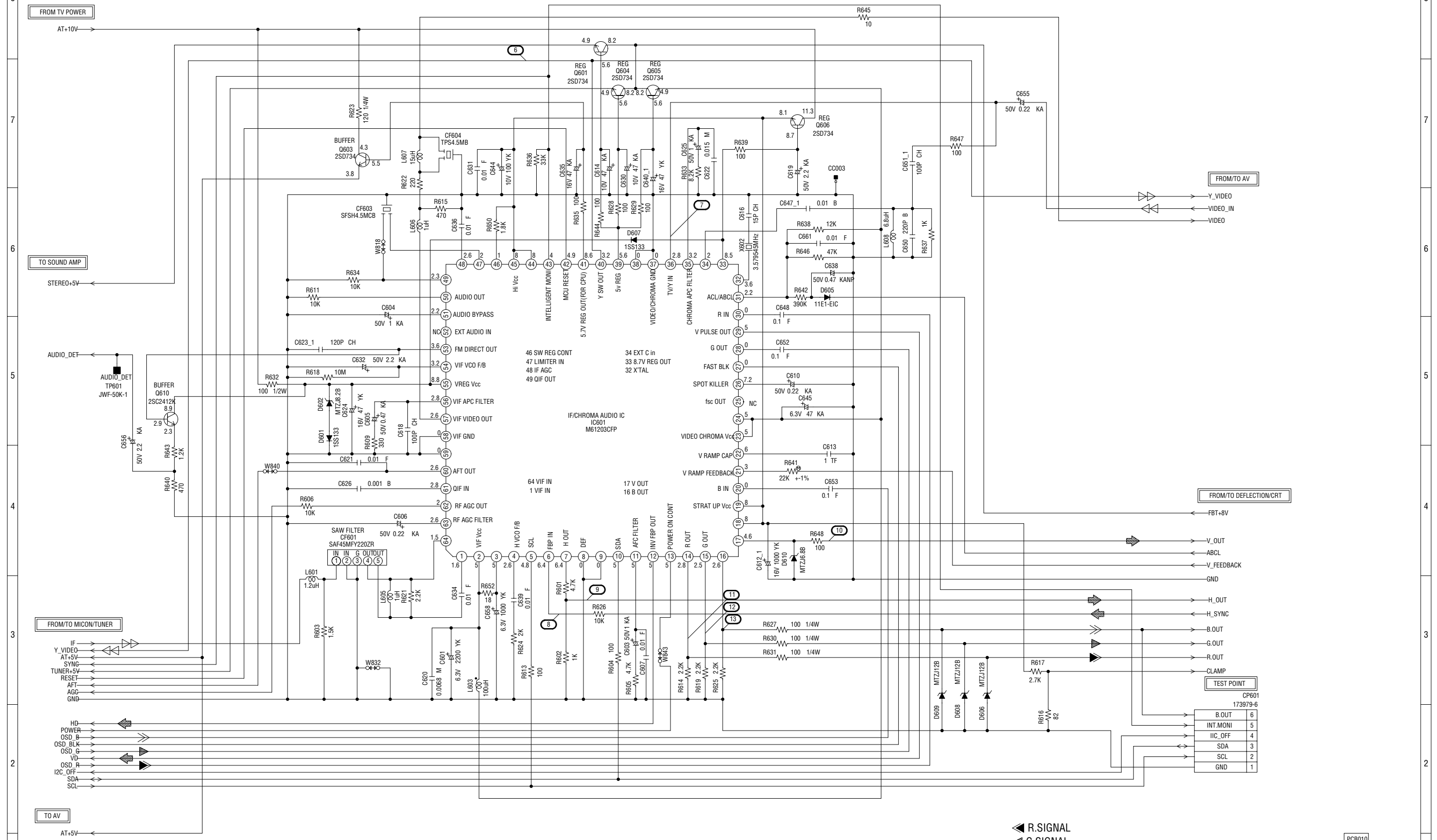

NOTE: THIS SCHEMATIC DIAGRAM IS THE LATEST AT THE TIME OF PRINTING AND SUBJECT TO CHANGE WITHOUT NOTICE.

NOTE: THE DC VOLTAGE AT EACH PART WAS MEASURED WITH THE DIGITAL TESTER WHEN THE COLOR BROADCAST WAS RECEIVED IN GOOD CONDITION AND PICTURE IS NORMAL.

- ◀ R.SIGNAL
- ◀ G.SIGNAL
- ◀ B.SIGNAL
- ◀ DEFLECTION SIGNAL
- ◀ AUDIO SIGNAL
- ◀ LUMINANCE SIGNAL
- ◀ TUNER VIDEO SIGNAL

PCB010
TMX474

DEFLECTION/CRT SCHEMATIC DIAGRAM(MAIN PCB)

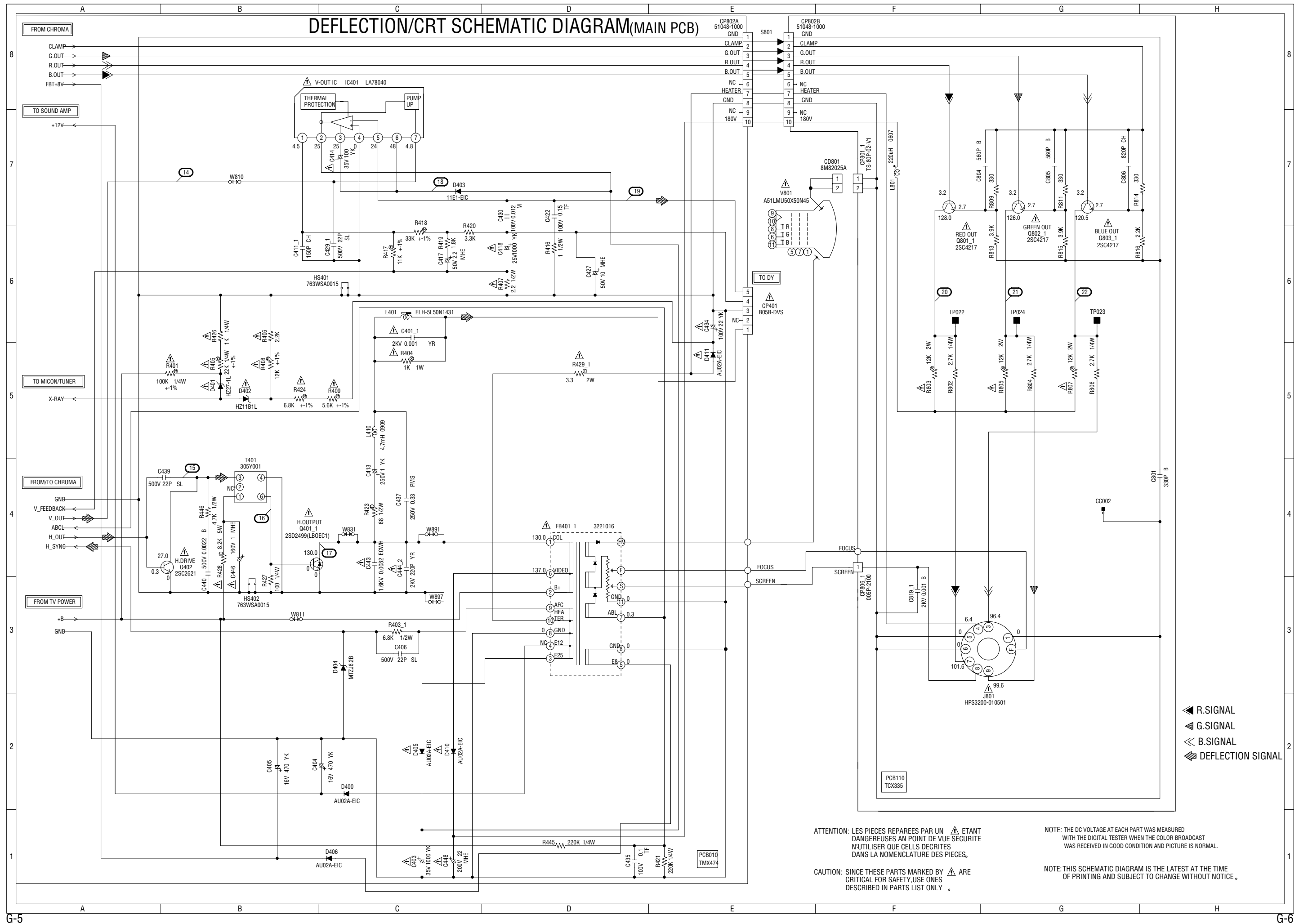

ATTENTION: LES PIÉCES RÉPARÉES PAR UN ÉTANT DANGEREUSES AN POINT DE VUE SECURITE N'UTILISER QUE CELLS DECRITES DANS LA NOMENCLATURE DES PIÉCES.

CAUTION: SINCE THESE PARTS MARKED BY ARE CRITICAL FOR SAFETY, USE ONES DESCRIBED IN PARTS LIST ONLY.

NOTE: THE DC VOLTAGE AT EACH PART WAS MEASURED WITH THE DIGITAL TESTER WHEN THE COLOR BROADCAST WAS RECEIVED IN GOOD CONDITION AND PICTURE IS NORMAL.

NOTE: THIS SCHEMATIC DIAGRAM IS THE LATEST AT THE TIME OF PRINTING AND SUBJECT TO CHANGE WITHOUT NOTICE.

- R.SIGNAL
- G.SIGNAL
- B.SIGNAL
- DEFLECTION SIGNAL

TV POWER SCHEMATIC DIAGRAM (MAIN PCB)

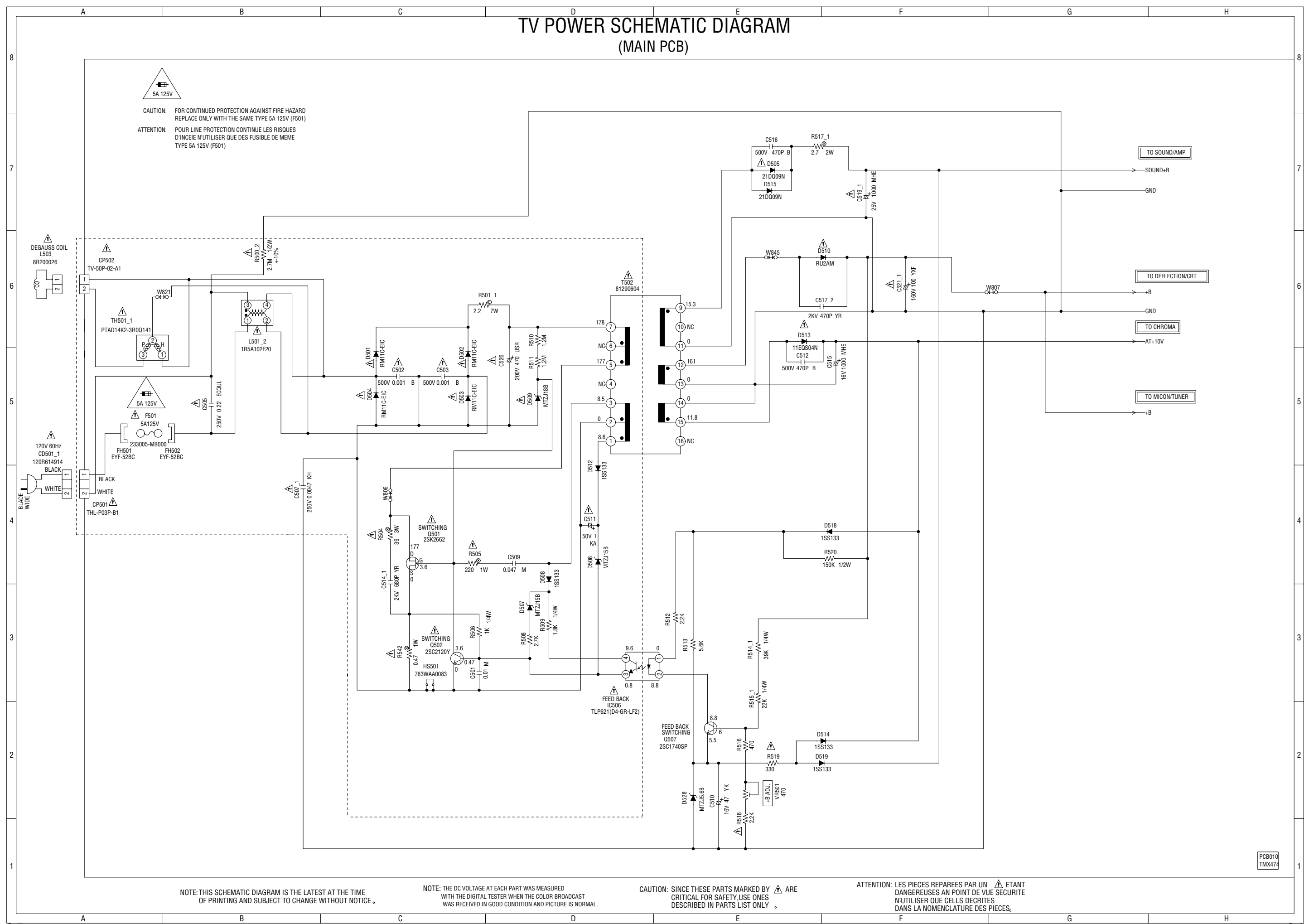

CAUTION: FOR CONTINUED PROTECTION AGAINST FIRE HAZARD
REPLACE ONLY WITH THE SAME TYPE 5A 125V (F501)

ATTENTION: POUR LINE PROTECTION CONTINUE LES RISQUES
D'INCENDIE N'UTILISER QUE DES FUSIBLE DE MEME
TYPE 5A 125V (F501)

NOTE: THIS SCHEMATIC DIAGRAM IS THE LATEST AT THE TIME
OF PRINTING AND SUBJECT TO CHANGE WITHOUT NOTICE.

NOTE: THE DC VOLTAGE AT EACH PART WAS MEASURED
WITH THE DIGITAL TESTER WHEN THE COLOR BROADCAST
WAS RECEIVED IN GOOD CONDITION AND PICTURE IS NORMAL.

CAUTION: SINCE THESE PARTS MARKED BY ARE
CRITICAL FOR SAFETY, USE ONES
DESCRIBED IN PARTS LIST ONLY.

ATTENTION: LES PIECES REPARÉES PAR UN ETANT
DANGEREUSES AN POINT DE VUE SECURITE
N'UTILISER QUE CELLS DECRITES
DANS LA NOMENCLATURE DES PIECES.

PCB010
TMX474

SOUND AMP SCHEMATIC DIAGRAM (MAIN PCB)

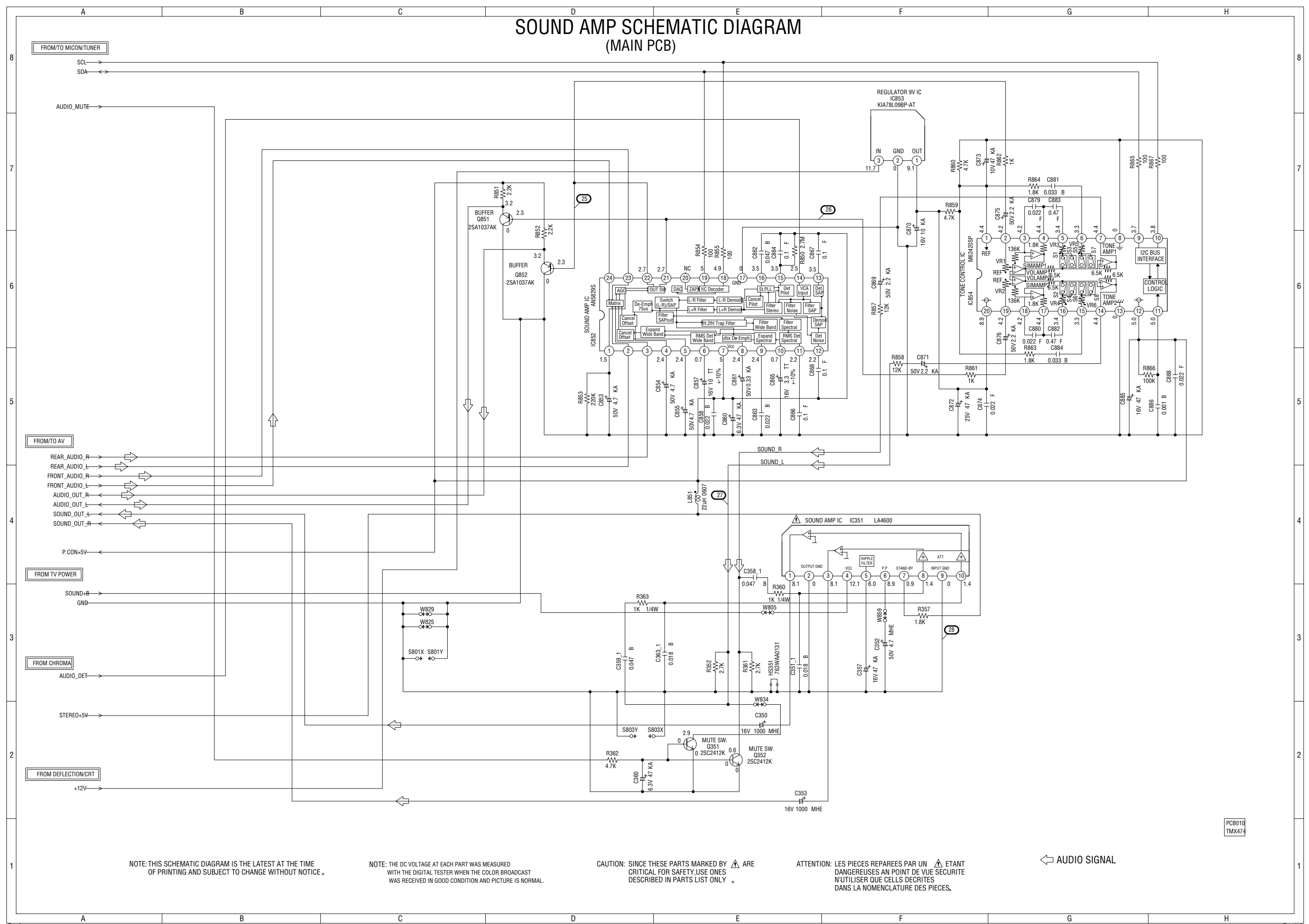

FROM/TO MICON/TUNER

FROM/TO AV

FROM TV POWER

FROM CHROMA

FROM DEFLECTION/CRT

NOTE: THIS SCHEMATIC DIAGRAM IS THE LATEST AT THE TIME OF PRINTING AND SUBJECT TO CHANGE WITHOUT NOTICE.

NOTE: THE DC VOLTAGE AT EACH PART WAS MEASURED WITH THE DIGITAL TESTER WHEN THE COLOR BROADCAST WAS RECEIVED IN GOOD CONDITION AND PICTURE IS NORMAL.

CAUTION: SINCE THESE PARTS MARKED BY ARE CRITICAL FOR SAFETY, USE ONES DESCRIBED IN PARTS LIST ONLY.

ATTENTION: LES PIECES REPARÉES PAR UN ÉTANT DANGEREUSES AN POINT DE VUE SECURITE N'UTILISER QUE CELLS DECRITES DANS LA NOMENCLATURE DES PIECES.

AUDIO SIGNAL

PCB010
TMX474

AV SCHEMATIC DIAGRAM (MAIN PCB)

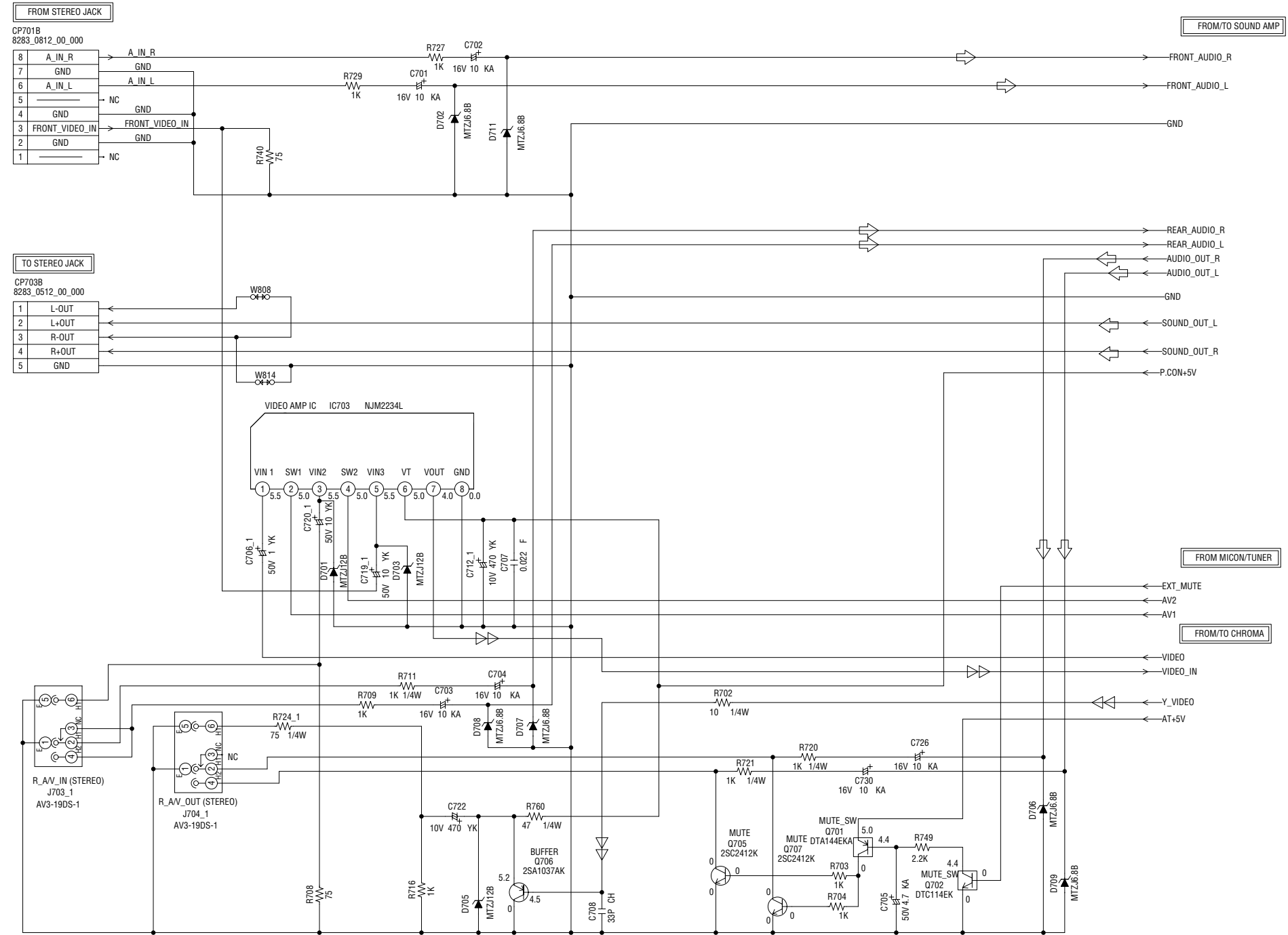

NOTE: THE DC VOLTAGE AT EACH PART WAS MEASURED WITH THE DIGITAL TESTER WHEN THE COLOR BROADCAST WAS RECEIVED IN GOOD CONDITION AND PICTURE IS NORMAL.

NOTE: THIS SCHEMATIC DIAGRAM IS THE LATEST AT THE TIME OF PRINTING AND SUBJECT TO CHANGE WITHOUT NOTICE.

CAUTION: DIGITAL TRANSISTOR

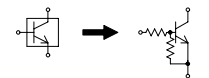

CAUTION: DIGITAL TRANSISTOR

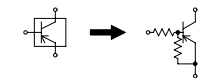

➡ AUDIO SIGNAL

⬅ TUNER VIDEO SIGNAL

PCB010
TMX474

STEREO JACK SCHEMATIC DIAGRAM (STEREO JACK PCB)

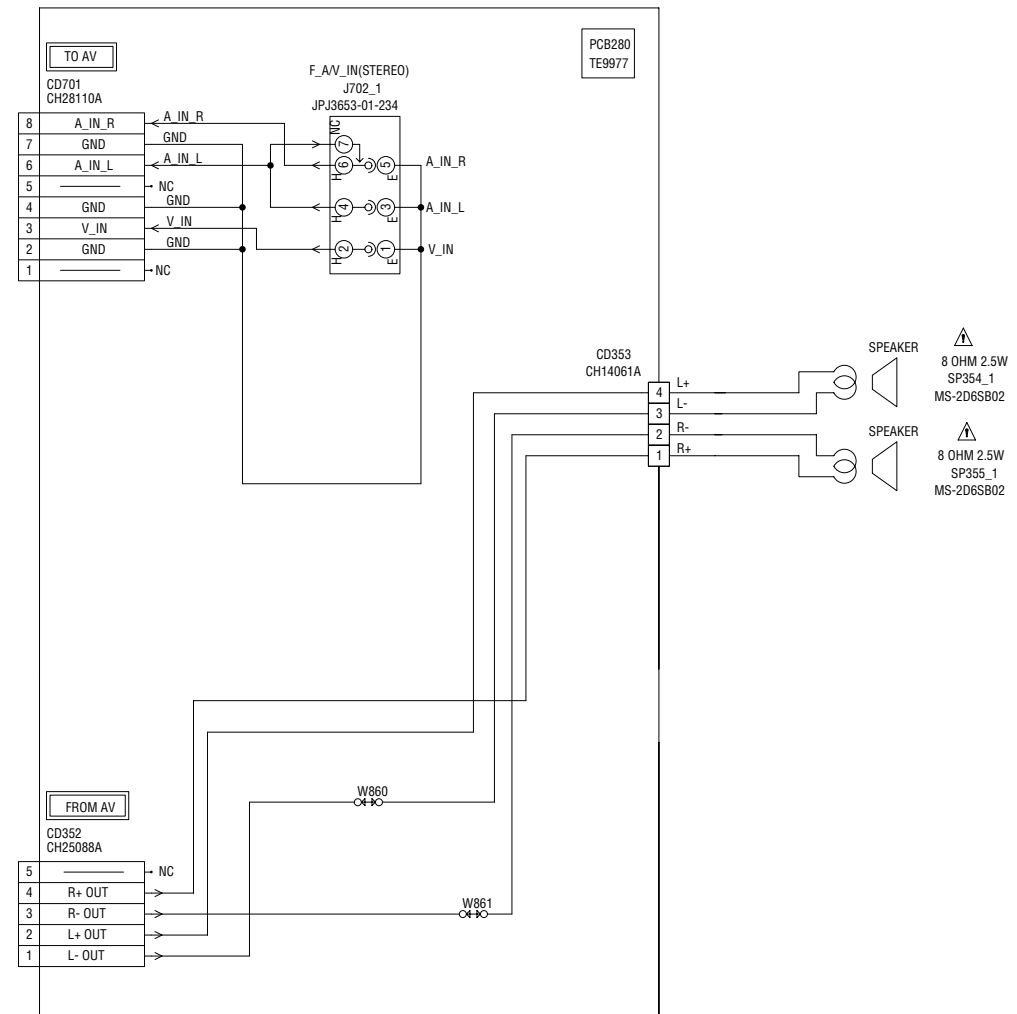

NOTE: THIS SCHEMATIC DIAGRAM IS THE LATEST AT THE TIME
OF PRINTING AND SUBJECT TO CHANGE WITHOUT NOTICE .

WAVEFORMS

MICON/TUNER

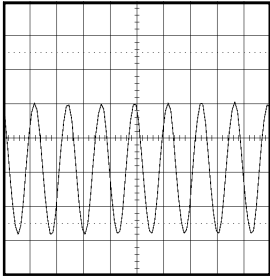

① 200mV 5ms/div

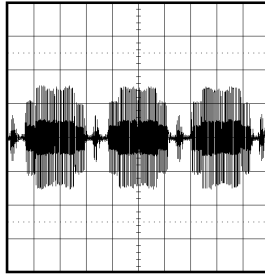

⑦ 200mV 20μs/div

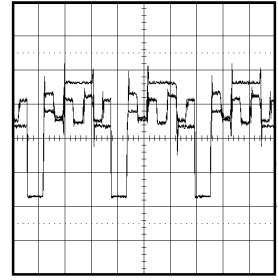

⑫ 1V 20μs/div

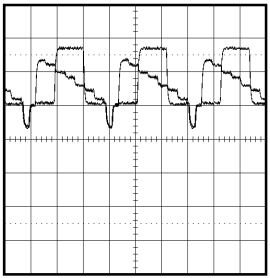

② 0.5V 20μs/div

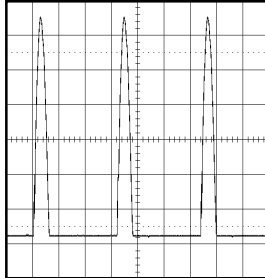

⑧ 20V 20μs/div

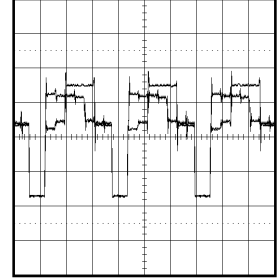

⑬ 1V 20μs/div

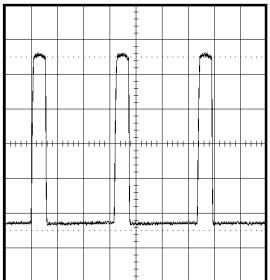

③ 200mV 20μs/div

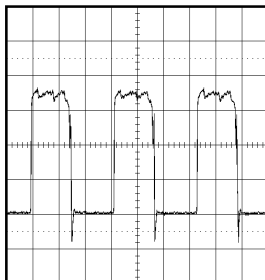

⑨ 200mV 20μs/div

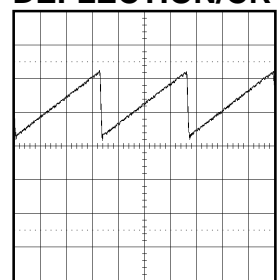

⑭ 0.5V 5ms/div

DEFLECTION/CRT

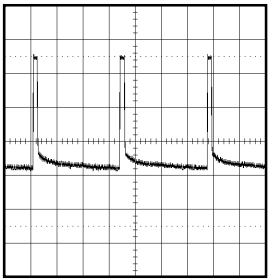

④ 200mV 5ms/div

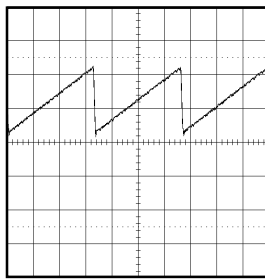

⑩ 0.5V 5ms/div

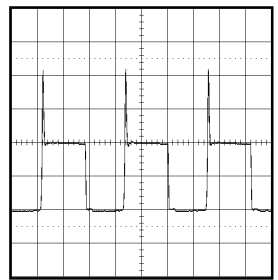

⑮ 20V 20μs/div

CHROMA

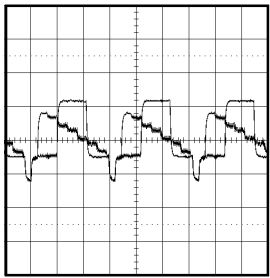

⑥ 0.5V 20μs/div

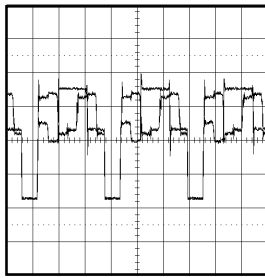

⑪ 1V 20μs/div

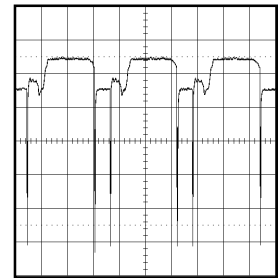

⑯ 2V 20μs/div

NOTE: The following waveforms were measured at the point of the corresponding balloon number in the schematic diagram.

WAVEFORMS

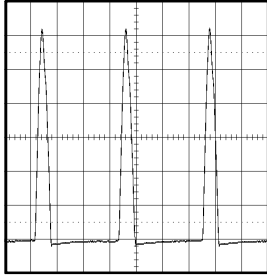

⑰ 200V 20 μ s/div

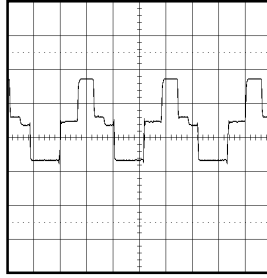

⑳ 50V 20 μ s/div

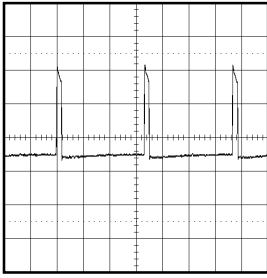

⑱ 10V 5ms/div

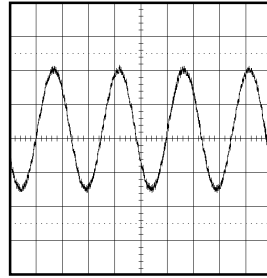

㉕ 200mV 1ms/div

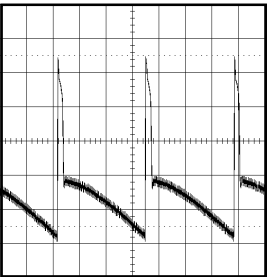

⑲ 10V 5ms/div

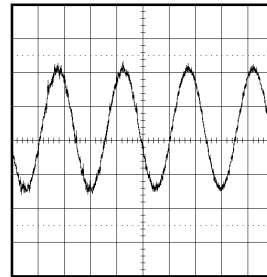

㉖ 200mV 1ms/div

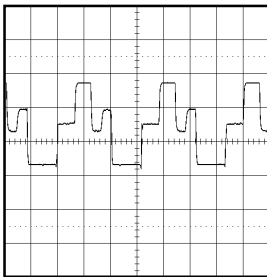

㉚ 50V 20 μ s/div

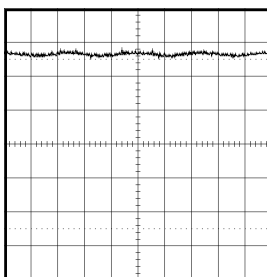

㉗ 0.5V 1ms/div

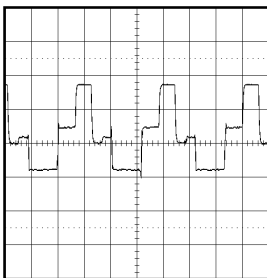

㉛ 50V 20 μ s/div

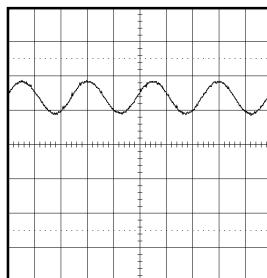

㉘ 1V 1ms/div

NOTE: The following waveforms were measured at the point of the corresponding balloon number in the schematic diagram.

MECHANICAL EXPLODED VIEW

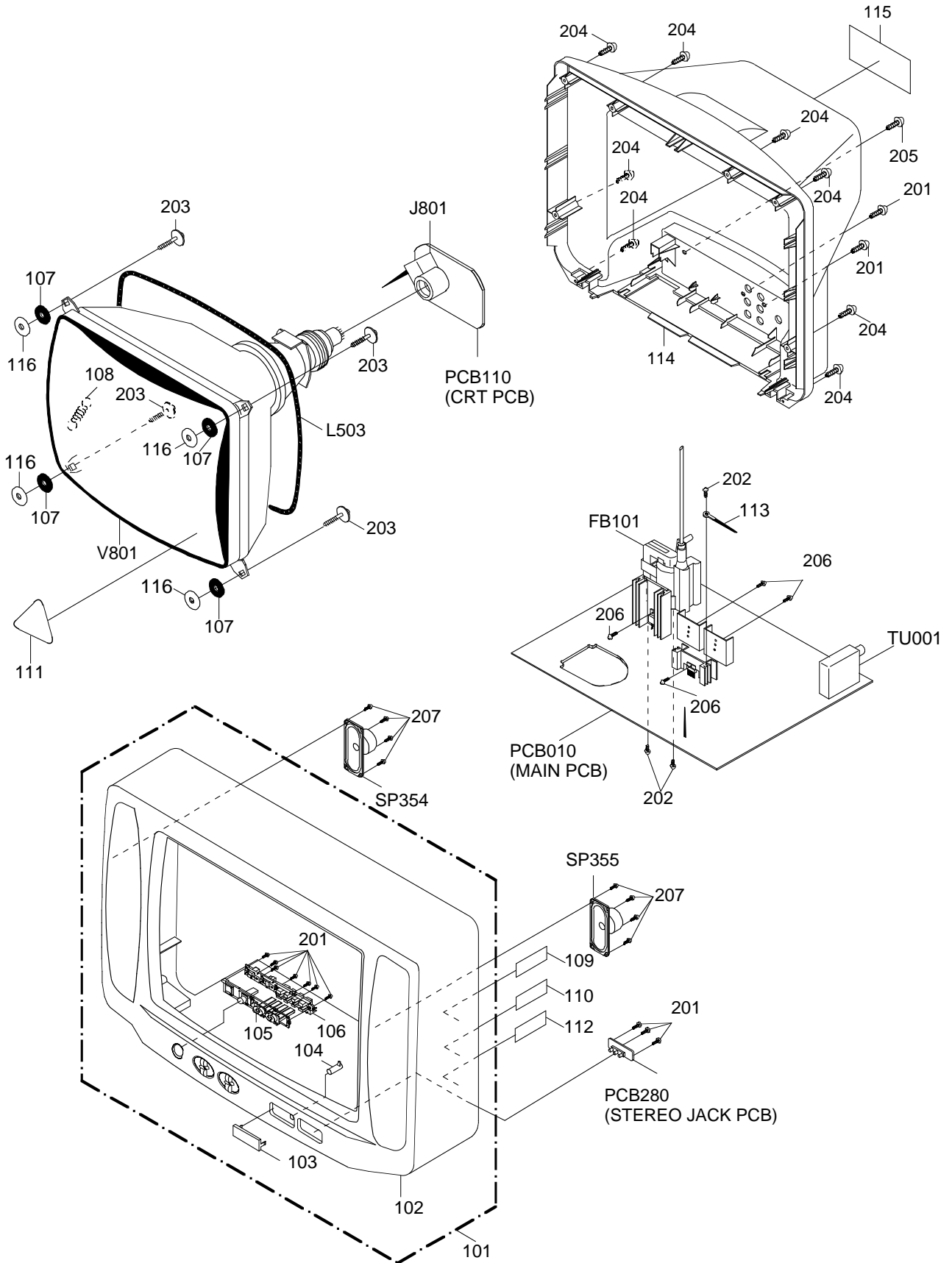

MECHANICAL REPLACEMENT PARTS LIST

REF. NO.	PART NO.	DESCRIPTION
101	A3G853J720	CABINET,FRONT ASS'Y
102	701WPJB240	CABINET,FRONT
103	711WPAA065	PLATE,DISPLAY
104	713WPAA010	GUIDE,REMOCON
105	735WPBA220	BUTTON,CHANNEL
106	735WPAA279	BUTTON,BASE
107	800WR0A003	SHEET,CRT SUPPORT
108	741WUA0001	SPRING,EARTH
109	7220001107	SHEET,HWC
110	7220001119	SHEET,CSA WARNING
111	723000A900	FILM,DECORATION
112	726000A014	SHEET,CRT SERVICEMAN
113	8995034000	CORD CLIP UL CO.
114	702WPAA129	CABINET,BACK
115	722A08A081	SHEET,RATING
116	769WSAA003	WASHER 9.5x22xT2
201	8110630A04	SCREW,TAP TITE (P) BRAZIER 3x10
202	8110630802	SCREW,TAP TITE (P) BRAZIER 3x8
203	8111J50D04	SCREW,TAPPING (A) GW22 5x40
204	8117540A64	SCREW,TAPPING (B0) TRUSS 4x16
205	8117540A04	SCREW,TAPPING (B0) TRUSS 4x10
206	8109I30A04	SCREW,TAP TITE (B) WH7 3x10
207	8117330A04	SCREW,TAPPING (B0) FLAT 3x10
---	JB5K0100	POLY BAG
---	J3G85301	INSTRUCTION BOOK
---	791WHA0025	LAMIFILM BAG
---	792WHA0199	PACKAGE, TOP
---	792WHA0200	PACKAGE, BOTTOM
---	A3G853J975	INSTRUCTION BOOK KIT
---	793WCDA937	GIFT BOX

ELECTRICAL REPLACEMENT PARTS LIST

REF. NO.	PART NO.	DESCRIPTION	REF. NO.	PART NO.	DESCRIPTION
RESISTORS			DIODES		
△ R001	R3X18A333J	R,METAL OXIDE	D508	D1VT001330	DIODE,SILICON
△ R401	R4X5T4104F	R,METAL	△ D509	D97U01801B	DIODE,ZENER
△ R404	R3X181102J	R,METAL OXIDE	△ D510	D2BTRU2AM0	DIODE,SILICON
△ R405	R4X5T4223F	R,METAL	D512	D1VT001330	DIODE,SILICON
△ R406	R801R7222J	RC	△ D513	D28XQS04N0	DIODE,SCHOTTKY
△ R407	R002T22R2J	RC	D514	D1VT001330	DIODE,SILICON
△ R408	R4X5T6123F	R,METAL	D515	D28T21DQN9	DIODE,SCHOTTKY
△ R409	R4X5T6562F	R,METAL	D518	D1VT001330	DIODE,SILICON
△ R424	R4X5T6682F	R,METAL	D519	D1VT001330	DIODE,SILICON
△ R426	R002T4102J	RC	D528	D97U05R61B	DIODE,ZENER
△ R428	R5X2CD822J	R,CEMENT	D601	D1VT001330	DIODE,SILICON
△ R429	R6558A3R3J	R,FUSE	D602	D97U08R21B	DIODE,ZENER
△ R500	ROG3K2275K	RC		D92UA8R2B2	DIODE,ZENER
R501	R5X2CE2R2J	R,CEMENT	D605	D2WT011E10	DIODE,SILICON
△ R504	R3X28B390J	R,METAL OXIDE	D606	D97U01201B	DIODE,ZENER
△ R505	R3X181221J	R,METAL OXIDE	D607	D1VT001330	DIODE,SILICON
R509	R002T4182J	RC	D608	D97U01201B	DIODE,ZENER
R517	R3X28A2R7J	R,METAL	D609	D97U01201B	DIODE,ZENER
△ R518	R801R7222J	RC	D610	D97U06R81B	DIODE,ZENER
△ R519	R801R7331J	RC	D701	D97U01201B	DIODE,ZENER
△ R542	R3X181R47J	R,METAL	D702	D97U06R81B	DIODE,ZENER
R629	R801R7101J	RC	D703	D97U01201B	DIODE,ZENER
△ R803	R3X18A123J	R,METAL OXIDE	D705	D97U01201B	DIODE,ZENER
	R3K18A123J	R,METAL	D706	D97U06R81B	DIODE,ZENER
△ R805	R3X18A123J	R,METAL OXIDE	D707	D97U06R81B	DIODE,ZENER
	R3K18A123J	R,METAL	D708	D97U06R81B	DIODE,ZENER
△ R807	R3X18A123J	R,METAL OXIDE	D709	D97U06R81B	DIODE,ZENER
	R3K18A123J	R,METAL	D711	D97U06R81B	DIODE,ZENER
CAPACITORS			ICS		
△ C401	C0JLYR713K	CC	IC101	I56F07044C	IC
	C01BBP713K	CC	IC199	A3G851J015	IC
△ C403	E02LF4102M	CE	△ IC351	I03SP46000	IC
△ C414	E02LT4101M	CE	△ IC401	I03TD80400	IC
△ C418	E02LF3102M	CE	△ IC506	0002500560	PHOTO COUPLER
△ C434	E02LT8220M	CE	IC601	I06FC1203C	IC
C437	P4J7F3334J	CMPP	IC703	I0QS02234L	IC
△ C443	P414F9822H	CMPP	IC852	I01FF58290	IC
△ C444	C0JLYR7H2K	CC	IC853	I1KJ98L090	IC
△ C446	E5EZTB010M	CE	IC854	I06DF62420	IC
	E53ZTB010M	CE	TRANSISTORS		
	E53ZTD010M	CE	Q351	T8YJ2412K0	TRANSISTOR,SILICON
△ C448	E5EZFC220M	CE	Q352	T8YJ2412K0	TRANSISTOR,SILICON
△ C502	C0JTB0513K	CC	△ Q401	TDUU024990	TRANSISTOR,SILICON
△ C503	C0JTB0513K	CC	△ Q402	TC3Q026210	TRANSISTOR,SILICON
△ C505	P2122B224M	COMP	△ Q501	T25FK26620	TRANSISTOR, FIELD EFFECT
△ C507	CB3HE0MQ3M	CC	△ Q502	TC5T021204	TRANSISTOR,SILICON
△ C511	E50HU5010M	CE	Q507	TCYT1740S0	TRANSISTOR,SILICON
C514	C0JLYR7U2K	CC	Q601	TD3T007340	TRANSISTOR,SILICON
C515	E5EZT2102M	CE	Q603	TD3T007340	TRANSISTOR,SILICON
	E53ZT2102M	CE	Q604	TD3T007340	TRANSISTOR,SILICON
C517	C0JLYR7Q2K	CC	Q605	TD3T007340	TRANSISTOR,SILICON
△ C519	E5EZT3102M	CE	Q606	TD3T007340	TRANSISTOR,SILICON
	E02YT3102M	CE	Q610	T8YJ2412K0	TRANSISTOR,SILICON
△ C521	E62NFB101M	CE	Q701	TPYJD05001	COMPOUND TRANSISTOR
△ C526	E52DGC471M	CE	Q702	TNYTB05001	COMPOUND TRANSISTOR
C612	E0EL02102M	CE	Q705	T8YA2412K0	TRANSISTOR,SILICON
C620	P1S3T0682J	CP	Q706	T6YJ1037K0	TRANSISTOR,SILICON
C819	C0JBB0713K	CC	Q707	T8YA2412K0	TRANSISTOR,SILICON
DIODES			△ Q801	TC3F042170	TRANSISTOR,SILICON
D001	D94TA30013	DIODE,ZENER	△ Q802	TC3F042170	TRANSISTOR,SILICON
D400	D2WTAU02A0	DIODE,SILICON	△ Q803	TC3F042170	TRANSISTOR,SILICON
△ D401	D94TA27011	DIODE,ZENER	Q851	T6YJ1037K0	TRANSISTOR,SILICON
△ D402	D94TA11B11	DIODE,ZENER	Q852	T6YJ1037K0	TRANSISTOR,SILICON
D403	D2WT011E10	DIODE,SILICON	COILS & TRANSFORMERS		
D404	D97U06R21B	DIODE,ZENER	L101	021LA63R3K	COIL
	D92UA6R2B2	DIODE,ZENER	L401	022R000002	COIL,LINEARITY
△ D405	D2WTAU02A0	DIODE,SILICON	L410	021679472K	COIL
D406	D2WTAU02A0	DIODE,SILICON	△ L501	029T00A7M1	COIL,LINE FILTER
△ D410	D2WTAU02A0	DIODE,SILICON	△ L503	028R200026	COIL,DEGAUSS
△ D411	D2WTAU02A0	DIODE,SILICON	L601	021LA61R2M	COIL
△ D501	D2WTRM11C0	DIODE,SILICON	L603	02167D101K	COIL
△ D502	D2WTRM11C0	DIODE,SILICON	L605	021LA61R0M	COIL
△ D503	D2WTRM11C0	DIODE,SILICON	L606	021LA61R0M	COIL
△ D504	D2WTRM11C0	DIODE,SILICON	L607	021LA6150K	COIL
△ D505	D28T21DQN9	DIODE,SCHOTTKY	L608	021LA66R8K	COIL
D506	D97U01501B	DIODE,ZENER	L801	02167D221K	COIL
D507	D97U01501B	DIODE,ZENER	L851	02167D220K	COIL

ELECTRICAL REPLACEMENT PARTS LIST

REF. NO.	PART NO.	DESCRIPTION	
COILS & TRANSFORMERS			
T401	03305Y0018	TRANS,HORIZONTAL DRIVE	305Y001
△ T502	0481290604	TRANSFORMER,SWITCHING	8129060
JACKS			
J702	0602431015	RCA,JACK	JPJ3653-01-234
J703	060Q431018	RCA,JACK	AV3-19DS-1
J704	060Q431018	RCA,JACK	AV3-19DS-1
△ J801	066X120014	SOCKET,CRT	HPS3200-010501
SWITCHES			
SW103	0504201T31	SWITCH,TACT	SKHVBED010
SW104	0504201T31	SWITCH,TACT	SKHVBED010
SW105	0504201T31	SWITCH,TACT	SKHVBED010
SW106	0504201T31	SWITCH,TACT	SKHVBED010
SW107	0504201T31	SWITCH,TACT	SKHVBED010
VARIABLE RESISTORS			
VR501	V1163Q2BTC	VOLUME,SEMI FIXED	EVNCYAA03BQ2 or
	V1163Q2BT6	VOLUME,SEMI FIXED	EVNDXAA03BQ2
P.C.BOARD ASSEMBLIES			
PCB010	A3G853J01A	PCB ASS'Y	TMX474A
PCB110	A3G853J11A	PCB ASS'Y	TCX335A
PCB280	A3G853J28A	PCB ASS'Y	TE9977A
MISCELLANEOUS			
CD352	06CH25088A	CORD,CONNECTOR	CH25088A
CD353	06CH14061A	CORD,CONNECTOR	CH14061A
△ CD501	120R614914	CORD,AC	120R614914
CD701	06CH28110A	CORD,CONNECTOR	CH28110A
CD801	068M82025A	CORD,CONNECTOR	8M82025A
CF601	1022T45R72	FILTER,SAW	SAF45MFY220ZR
CF603	1012T4R509	FILTER,CERAMIC	SFSH4.5MCB-TF21
CF604	1012T4R503	FILTER,CERAMIC TRAP	TPS4.5MB-TF21
△ CP401	069X450029	CONNECTOR PCB SIDE	B05B-DVS
△ CP501	0697320039	CORD,UX CONNECTOR	THL-P03P-B1
△ CP502	069W420029	CONNECTOR PCB SIDE	TV-50P-02-A1
CP601	0694260139	CONNECTOR PCB SIDE	173979-6
CP801	069D320018	CONNECTOR PCB SIDE	TS-80P-02-V1
CP806	069D010010	CONNECTOR PCB SIDE	005P-2100
CP701B	069E280129	CONNECTOR PCB SIDE	8283_0812_00_000
CP703B	069E250129	CONNECTOR PCB SIDE	8283_0512_00_000
CP802A	067R010019	WIRE HOLDER	51048-1010
CP802B	067R010019	WIRE HOLDER	51048-1010
EL001	124120301A	EYE LET	XRY20X30BD
△ F501	081PA05003	FUSE	233005-MB000
△ FB401	043221016A	TRANSFORMER,FLYBACK	3221016
FH501	06710T0006	HOLDER,FUSE	EYF-52BC
FH502	06710T0006	HOLDER,FUSE	EYF-52BC
OS101	077Q014003	REMOTE RECEIVER	PIC-28143SY-2
△ SP354	070W463002	SPEAKER	MS-2D6SB02
△ SP355	070W463002	SPEAKER	MS-2D6SB02
△ TH501	DF40A3R0Q0	DEGAUSS,ELEMENT	PTAD14K2-3R0Q141
TM101	076N0DW040	TRANSMITTER	RC-DW040
TU001	0145S00052	TUNER,VHF-UHF	ENV56D66G3
△ V801	098Y210412	CRT W/DY	A51LMU50X50N45
X101	1002T00802	CERAMIC OSCILLATOR	CSTS0800MG03-T2
X602	100CT3R505	CRYSTAL HC-49/C	3.579545MHz

RESISTOR

RC..... CARBON RESISTOR

CAPACITORS

CC..... CERAMIC CAPACITOR
 CE..... ALUMI ELECTROLYTIC CAPACITOR
 CP..... POLYESTER CAPACITOR
 CPP..... POLYPROPYLENE CAPACITOR
 CPL..... PLASTIC CAPACITOR
 CMP..... METAL POLYESTER CAPACITOR
 CMPL..... METAL PLASTIC CAPACITOR
 CMPP..... METAL POLYPROPYLENE CAPACITOR

SPEC.NO.	M3G8-53J
O/R NO.	W143007

SERVICING NOTICES ON CHECKING

1. KEEP THE NOTICES

As for the places which need special attentions, they are indicated with the labels or seals on the cabinet, chassis and parts. Make sure to keep the indications and notices in the operation manual.

2. AVOID AN ELECTRIC SHOCK

There is a high voltage part inside. Avoid an electric shock while the electric current is flowing.

3. USE THE DESIGNATED PARTS

The parts in this equipment have the specific characters of incombustibility and withstand voltage for safety. Therefore, the part which is replaced should be used the part which has the same character.

Especially as to the important parts for safety which is indicated in the circuit diagram or the table of parts as a \triangle mark, the designated parts must be used.

4. PUT PARTS AND WIRES IN THE ORIGINAL POSITION AFTER ASSEMBLING OR WIRING

There are parts which use the insulation material such as a tube or tape for safety, or which are assembled in the condition that these do not contact with the printed board. The inside wiring is designed not to get closer to the pyrogenic parts and high voltage parts. Therefore, put these parts in the original positions.

5. TAKE CARE TO DEAL WITH THE CATHODE-RAY TUBE

In the condition that an explosion-proof cathode-ray tube is set in this equipment, safety is secured against implosion. However, when removing it or serving from backward, it is dangerous to give a shock. Take enough care to deal with it.

6. AVOID AN X-RAY

Safety is secured against an X-ray by considering about the cathode-ray tube and the high voltage peripheral circuit, etc.

Therefore, when repairing the high voltage peripheral circuit, use the designated parts and make sure not modify the circuit.

Repairing except indicates causes rising of high voltage, and it emits an X-ray from the cathode-ray tube.

7. PERFORM A SAFETY CHECK AFTER SERVICING

Confirm that the screws, parts and wiring which were removed in order to service are put in the original positions, or whether there are the portions which are deteriorated around the serviced places serviced or not. Check the insulation between the antenna terminal or external metal and the AC cord plug blades. And be sure the safety of that.

(INSULATION CHECK PROCEDURE)

1. Unplug the plug from the AC outlet.
2. Remove the antenna terminal on TV and turn on the TV.
3. Insulation resistance between the cord plug terminals and the external exposure metal **[Note 2]** should be more than 1M ohm by using the 500V insulation resistance meter **[Note 1]**.
4. If the insulation resistance is less than 1M ohm, the inspection repair should be required.

[Note 1]

If you have not the 500V insulation resistance meter, use a Tester.

[Note 2]

External exposure metal: Antenna terminal

HOW TO ORDER PARTS

Please include the following informations when you order parts. (Particularly the VERSION LETTER.)

1. MODEL NUMBER and VERSION LETTER

The MODEL NUMBER can be found on the back of each product and the VERSION LETTER can be found at the end of the SERIAL NUMBER.

2. PART NO. and DESCRIPTION

You can find it in your SERVICE MANUAL.

IMPORTANT

Inferior silicon grease can damage IC's and transistors.

When replacing an IC's or transistors, use only specified silicon grease (YG6260M).

Remove all old silicon before applying new silicon.

CONTENTS

SERVICING NOTICES ON CHECKING	A1-1
HOW TO ORDER PARTS	A1-1
IMPORTANT	A1-1
CONTENTS	A2-1
GENERAL SPECIFICATIONS	A3-1~A3-4
DISASSEMBLY INSTRUCTIONS	B-1
SERVICE MODE LIST	C-1
CONFIRMATION OF USING HOURS	C-1
NOTE FOR THE REPLACING OF MEMORY IC	C-1
ELECTRICAL ADJUSTMENTS	D1-1~D2-1
MAJOR COMPONENTS LOCATION GUIDE	D3-1
BLOCK DIAGRAM	E-1, E-2
PRINTED CIRCUIT BOARDS	
MAIN/CRT/STEREO JACK	F-1, F-2
MAIN/CRT	F-3, F-4
SCHEMATIC DIAGRAMS	
MICON/TUNER	G-1, G-2
CHROMA	G-3, G-4
DEFLECTION/CRT	G-5, G-6
TV POWER	G-7, G-8
SOUND AMP	G-9, G-10
AV	G-11, G-12
STEREO JACK	G-13, G-14
WAVEFORMS	H-1, H-2
MECHANICAL EXPLODED VIEW	I-1
MECHANICAL REPLACEMENT PARTS LIST	J1-1
ELECTRICAL REPLACEMENT PARTS LIST	J2-1, J2-2

GENERAL SPECIFICATIONS

G-1.Outline of the Product

20 inch(508.0mmV):Measured diagonally
Color CRT 90 degree deflection

G-2.Broadcasting System

US System M

G-3.Color System NTSC PAL SECAM or Monochrome signal

G-4.NTSC Playback(PAL 60Hz) Yes No

G-5.NTSC 3.58+4.43/PAL60Hz Yes No

G-6.Antenna Input Impedance

VHF/UHF 75 ohm unbalanced

G-7.Tuner and Receiving

Contactless Electric tuner

1Tuner System

2Tuner System

channel Tuner

Oscar(W/O HYPER)

Oscar(W/ HYPER)

France CATV)

Others

Receiving channel

VHF (LOW) 2 ch ~ 6 ch

(HIGH) 7 ch ~ 13 ch

(CATV) A5 ch ~ I ch J ch~W+29 ch GGG ch~W+84 ch

UHF 14 ch ~ 69 ch

Tuning System

Frequency syn.

Voltage syn.

Others

G-8.Preset Channel

-- channels

G-9.Intermediate Frequency

Picture(fP) 45.75 MHz MHz MHz

Sound (fS) 41.25 MHz MHz MHz

fP-fS 4.50 MHz MHz MHz

G-10.Stereo/Dual TV Sound

Yes(NICAM GERMAN USA JAPAN) No

G-11.Tuner Sound Muting

Yes No

G-12.Power Source

120 V AC 50Hz AC 60Hz

G-13.Power Consumption:

95 W at AC 120 V 60 Hz

-- W at DC --- V

Stand by: 8 W at AC V Hz

Per Year: -- kWh / Year

G-14.Dimensions(Approx.)

600 mm(W) 479 mm(D) 446 mm(H)

G-15.Weight(Approx.)

Net : 21.0 kg (.46.3 lbs)

Gross: 23.8 kg (.52.5 lbs)

G-16.Cabinet Material

Cabinet Front:

PS

94HB

DECABROM

ABS

94V2

NON-DECA

94V0

Back Panel:

PS

94HB

DECABROM

ABS

94V2

NON-DECA

94V0

GENERAL SPECIFICATIONS

G-32.Switch

Front

- | | | |
|---|--|--|
| <input checked="" type="checkbox"/> Power(Tact) | <input checked="" type="checkbox"/> Channel Up/Reset | <input checked="" type="checkbox"/> Volume Up/Set Up |
| <input type="checkbox"/> System Select | <input checked="" type="checkbox"/> Channel Down/Enter | <input checked="" type="checkbox"/> Volume Down/Set Down |
| <input type="checkbox"/> Main Power SW | <input type="checkbox"/> Sub Power | <input checked="" type="checkbox"/> Menu:Vol UP+Vol Down |

Rear

- | | |
|----------------------------------|---|
| <input type="checkbox"/> AC/DC | <input type="checkbox"/> TV/CATV Selector |
| <input type="checkbox"/> Degauss | <input type="checkbox"/> Main Power SW |

G-33.Magnetic Field

- | | | |
|---|--------------------------------------|--------------------------------------|
| <input checked="" type="checkbox"/> BV : +0.45G | <input type="checkbox"/> BV : +0.35G | <input type="checkbox"/> BV : +0.25G |
| BH : 0.18G | BH : 0.30G | BH : 0.30G |
| <input type="checkbox"/> BV : -0.15G | <input type="checkbox"/> BV : -0.25G | <input type="checkbox"/> BV : -0.50G |
| BH : 0.15G | BH : 0.15G | BH : 0.30G |

G-34.Remote Control Unit:

Glow in Dark Remocon

Power Source:

Total 28 Key

- Power
- Stand By
- 0
- 1
- 2
- 3
- 4
- 5
- 6
- 7
- 8
- 9
- 10
- 11
- 12
- 1 *
- 2 *
- 0/10
- Tone 1/2
- Info
- Mono/Auto
- TV/Caption/Text
- Expand
- Red
- Cyan
- Normal
- Color System
- Wide Seley
- Auto Wide On/Off
- Picture Position
- Direct Change/Auto Search
- Picture Menu

RC-DW

Yes

D.C 3 V Battery UM - 4 x 2

No

- Quick View
- Status
- Time Select
- Time Set
- Muting
- CH Skip
- CH1/CH2
- Channel
- Text/Mix/TV
- Display Cancel
- Initial
- Store
- Reveal
- Sleep
- Aft/Skip
- Preset
- 5.5/6.5MHz
- Auto Memory
- Auto
- Call
- Reset
- Menu
- Enter
- Add
- Delete
- Yellow
- Random
- Tuning Up/Time Text
- Tuning Down/Reset
- Navi
- Back Light
- Mid Night Theater
- TV/AV
- Bar Select
- PAL/SECAM
- Volume Up
- Volume Down
- CH Call
- CH Down
- CH Up
- CH Down/Page Down
- CH Up/Page Up
- Page +/-
- Program
- F/T/B
- Hold
- List
- Rotate
- Browse
- Std/Auto
- Memory
- Band Select
- Search
- Clock/Program
- Clock/Set
- Ch Set
- Set +
- Set -
- Green
- Nicam/Mono
- Tone A/B
- FM Transmitter
- Audio Select

DISASSEMBLY INSTRUCTIONS

1. REMOVAL OF ANODE CAP

Read the following **NOTED** items before starting work.

- * After turning the power off there might still be a potential voltage that is very dangerous. When removing the Anode Cap, make sure to discharge the Anode Cap's potential voltage.
- * Do not use pliers to loosen or tighten the Anode Cap terminal, this may cause the spring to be damaged.

REMOVAL

1. Follow the steps as follows to discharge the Anode Cap. (Refer to Fig. 1-1.)

Connect one end of an Alligator Clip to the metal part of a flat-blade screwdriver and the other end to ground. While holding the plastic part of the insulated screwdriver, touch the support of the Anode with the tip of the screwdriver.

A cracking noise will be heard as the voltage is discharged.

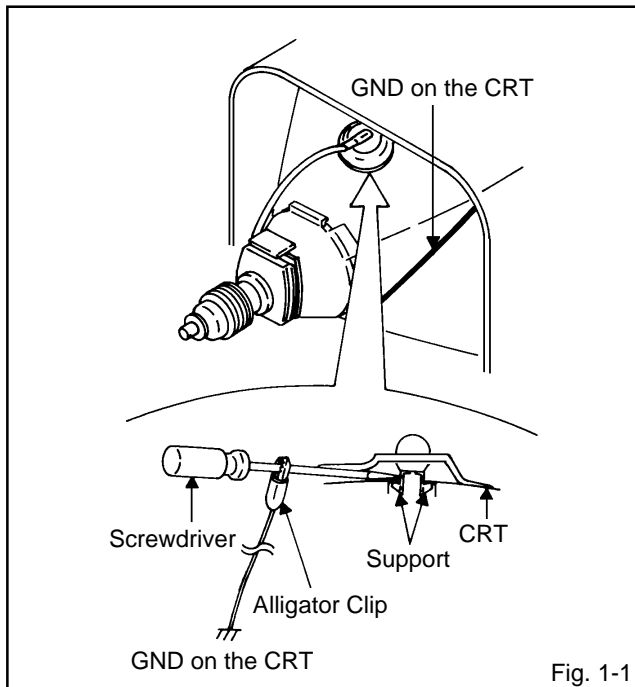

Fig. 1-1

2. Flip up the sides of the Rubber Cap in the direction of the arrow and remove one side of the support. (Refer to Fig. 1-2.)

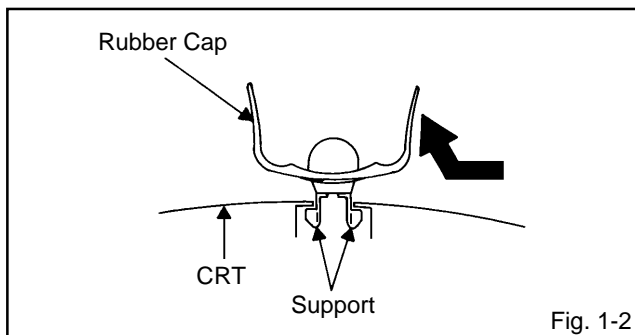

Fig. 1-2

3. After one side is removed, pull in the opposite direction to remove the other.

NOTE

Take care not to damage the Rubber Cap.

INSTALLATION

1. Clean the spot where the cap was located with a small amount of alcohol. (Refer to Fig. 1-3.)

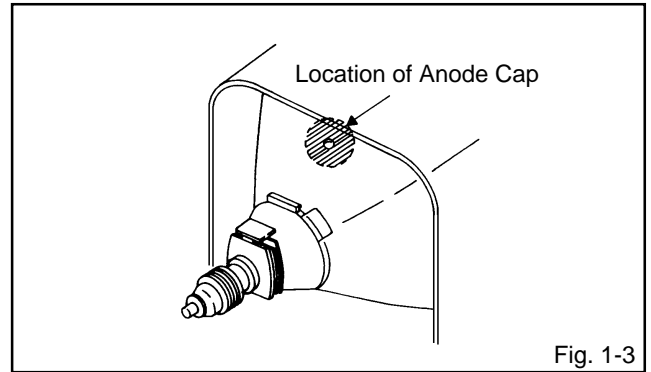

Fig. 1-3

NOTE

Confirm that there is no dirt, dust, etc. at the spot where the cap was located.

2. Arrange the wire of the Anode Cap and make sure the wire is not twisted.
3. Turn over the Rubber Cap. (Refer to Fig. 1-4.)

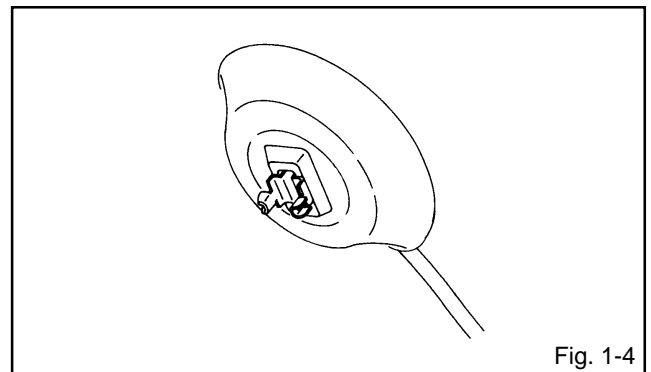

Fig. 1-4

4. Insert one end of the Anode Support into the anode button, then the other as shown in Fig. 1-5.

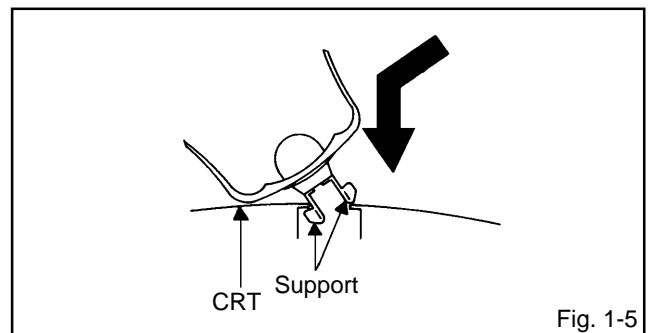

Fig. 1-5

5. Confirm that the Support is securely connected.
6. Put on the Rubber Cap without moving any parts.

SERVICE MODE LIST

This unit provided with the following SERVICE MODES so you can repair, examine and adjust easily. To enter the Service Mode, press both set key and remote control key for more than 1 second.

Set Key	Remocon Key	Operations
VOL. (-) MIN	0	Releasing of V-CHIP PASSWORD.
VOL. (-) MIN	1	Initialization of the factory. NOTE: Do not use this for the normal servicing.
VOL. (-) MIN	6	POWER ON total hours is displayed on the screen. Refer to the "CONFIRMATION OF USING HOURS". Can be checked of the INITIAL DATA of MEMORY IC. Refer to the "NOTE FOR THE REPLACING OF MEMORY IC".
VOL. (-) MIN	8	Writing of EEPROM initial data. NOTE: Do not use this for the normal servicing.
VOL. (-) MIN	9	Display of the Adjustment MENU on the screen. Refer to the "ELECTRICAL ADJUSTMENT" (On-Screen Display Adjustment).

CONFIRMATION OF USING HOURS

POWER ON total hours can be checked on the screen. Total hours are displayed in 16 system of notation.

1. Set the VOLUME to minimum.
2. Press both VOL. DOWN button on the set and Channel button **(6)** on the remote control for more than 1 second.
3. After the confirmation of using hours, turn off the power.

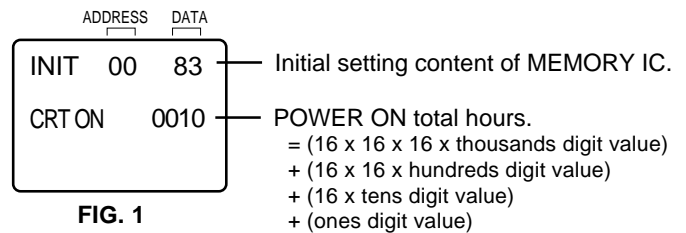

NOTE FOR THE REPLACING OF MEMORY IC

If a service repair is undertaken where it has been required to change the MEMORY IC, the following steps should be taken to ensure correct data settings while making reference to TABLE 1.

INI	+0	+1	+2	+3	+4	+5	+6	+7	+8	+9	+A
70	A9	FA	A2	09	06	63	24	3B	A3	00	FF

Table 1

1. Enter DATA SET mode by setting VOLUME to minimum.
2. Press both VOL. DOWN button on the set and Channel button **(6)** on the remote control for more than 1 second. ADDRESS and DATA should appear as FIG 1.
3. ADDRESS is now selected and should "blink". Using the SET + or - keys on the remote, step through the ADDRESS until required ADDRESS to be changed is reached.
4. Press ENTER to select DATA. When DATA is selected, it will "blink".
5. Again, step through the DATA using SET + or - until required DATA value has been selected.
6. Pressing ENTER will take you back to ADDRESS for further selection if necessary.
7. Repeat steps 3 to 6 until all data has been checked.
8. When satisfied correct DATA has been entered, turn POWER off (return to STANDBY MODE) to finish DATA input. The unit will now have the correct DATA for the new MEMORY IC.

ELECTRICAL ADJUSTMENTS

1. BEFORE MAKING ELECTRICAL ADJUSTMENTS

Read and perform these adjustments when repairing the circuits or replacing electrical parts or PCB assemblies.

CAUTION

- Use an isolation transformer when performing any service on this chassis.
- Before removing the anode cap, discharge electricity because it contains high voltage.
- When removing a PCB or related component, after unfastening or changing a wire, be sure to put the wire back in its original position.
Inferior silicon grease can damage IC's and transistors.
- When replacing IC's and transistors, use only specified silicon grease (YG6260M).
Remove all old silicon before applying new silicon.

Prepare the following measurement tools for electrical adjustments.

1. Synchro Scope
2. Digital Voltmeter

On-Screen Display Adjustment

1. In the condition of NO indication on the screen.
Press the VOL. DOWN button on the set and the Channel button (9) on the remote control for more than 1 second to appear the adjustment mode on the screen as shown in Fig. 1-1.

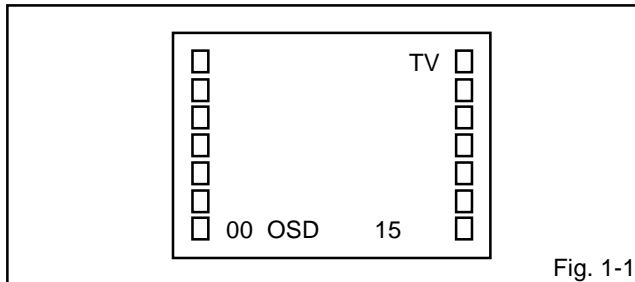

Fig. 1-1

2. Use the Channel UP/DOWN button or Channel button (0-9) on the remote control to select the options shown in Fig. 1-2.
3. Press the MENU button on the remote control to end the adjustments.

NO.	FUNCTION	NO.	FUNCTION
00	OSD H	13	BRIGHTNESS
01	CUT OFF	14	CONTRAST
02	RF DELAY	15	COLOR
03	VIF VCO	16	TINT
04	H VCO	17	SHARPNESS
05	H PHASE	18	FM LEVEL
06	V SIZE	19	LEVEL
07	V SHIFT	20	SEPARATION 1
08	R DRIVE	21	SEPARATION 2
09	B DRIVE	22	TEST MONO
10	R BIAS	23	TEST STEREO
11	G BIAS	24	X-RAY TEST
12	B BIAS		

Fig. 1-2

2. BASIC ADJUSTMENTS

2-1: RF AGC DELAY

1. Place the set with Aging Test for more than 15 minutes.
2. Receive an 65dB monoscope pattern.
3. Connect the digital voltmeter to TP001.
4. Activate the adjustment mode display of Fig. 1-1 and press the channel button (02) on the remote control to select "RF DELAY".
5. Press the VOL. UP/DOWN button on the remote control until the digital voltmeter is 3.1V.

2-2: CUT OFF

1. Adjust the unit to the following settings.
R.DRIVE=10, B.DRIVE=10, R.BIAS=64, G.BIAS=64, B.BIAS=64, BRIGHTNESS=110, CONTRAST=90.
2. Place the set with Aging Test for more than 15 minutes.
3. Activate the adjustment mode display of Fig. 1-1 and press the channel button (01) on the remote control to select "CUT OFF".
4. Adjust the Screen Volume until a dim raster is obtained.

2-3: FOCUS

1. Receive the monoscope pattern.
2. Turn the Focus Volume fully counterclockwise once.
3. Adjust the Focus Volume until picture is distinct.

2-4: WHITE BALANCE

NOTE: Adjust after performing CUT OFF adjustment.

1. Place the set with Aging Test for more than 15 minutes.
2. Receive the white 100% signal from the Pattern Generator.
3. Using the adjustment control, set the brightness and contrast to normal position.
4. Activate the adjustment mode display of Fig. 1-1 and press the channel button (10) on the remote control to select "R.BIAS".
5. Using the VOL. UP/DOWN button on the remote control, adjust the R.BIAS.
6. Press the CH. UP/DOWN button on the remote control to select the "R.DRIVE", "B.DRIVE", "G.BIAS" or "B.BIAS".
7. Using the VOL. UP/DOWN button on the remote control, adjust the R.DRIVE, B.DRIVE, G.BIAS or B.BIAS.
8. Perform the above adjustments 6 and 7 until the white color is looked like a white.

2-5: SUB TINT/SUB COLOR

1. Receive the color bar pattern. (RF Input)
2. Connect the oscilloscope to TP023.
3. Activate the adjustment mode display of Fig. 1-1 and press the channel button (16) on the remote control to select "TINT".
4. Press the VOL. UP/DOWN button on the remote control until the waveform becomes as shown in Fig. 2-1.
5. Connect the oscilloscope to TP022.
6. Press the CH DOWN button once to set to "COLOR" mode.
7. Press the VOL. UP/DOWN button on the remote control until the red color level is adjusted to 110% of the white level. (Refer to Fig. 2-2)
8. Receive the color bar pattern. (Audio Video Input)
9. Press the TV/AV button on the remote control to set to the AV mode. Then perform the above adjustments 2~7.

ELECTRICAL ADJUSTMENTS

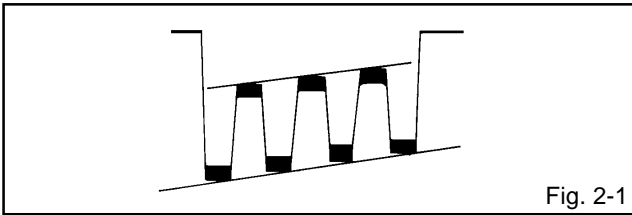

Fig. 2-1

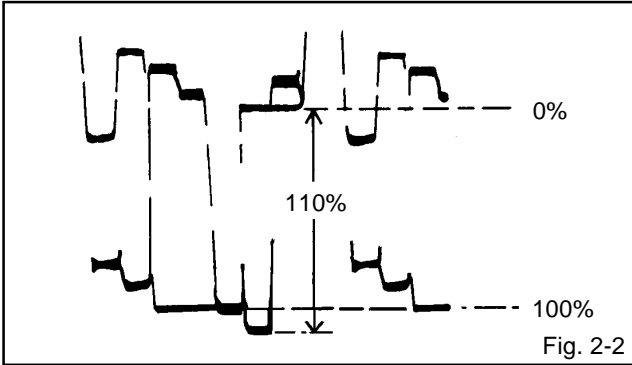

Fig. 2-2

2-6: HORIZONTAL PHASE

1. Receive the center cross signal from the Pattern Generator.
2. Using the remote control, set the brightness and contrast to normal position.
3. Activate the adjustment mode display of **Fig. 1-1** and press the channel button **(05)** on the remote control to select "H PHASE".
4. Press the VOL. UP/DOWN button on the remote control until the SHIFT quantity of the OVER SCAN on right and left becomes minimum.

2-7: VERTICAL SIZE

NOTE: Adjust after performing adjustments in section 2-6

1. Receive the crosshatch signal from the Pattern Generator.
2. Using the remote control, set the brightness and contrast to normal position.
3. Activate the adjustment mode display of **Fig. 1-1** and press the channel button **(06)** on the remote control to select "V SIZE".
4. Press the VOL. UP/DOWN button on the remote control until the rectangle on the center of the screen becomes square.
5. Receive a broadcast and check if the picture is normal.

2-8: VERTICAL SHIFT

NOTE: Adjust after performing adjustments in section 2-7

1. Receive the crosshatch signal from the Pattern Generator.
2. Using the remote control, set the brightness and contrast to normal position.
3. Activate the adjustment mode display of **Fig. 1-1** and press the channel button **(07)** on the remote control to select "V SHIFT".
4. Press the VOL. UP/DOWN button on the remote control until the horizontal line becomes fit to the notch of the shabow mask.

2-9: OSD HORIZONTAL

1. Activate the adjustment mode display of **Fig. 1-1**.
2. Press the VOL. UP/DOWN button on the remote control until the difference of A and B becomes minimum. (Refer to **Fig. 2-3**)

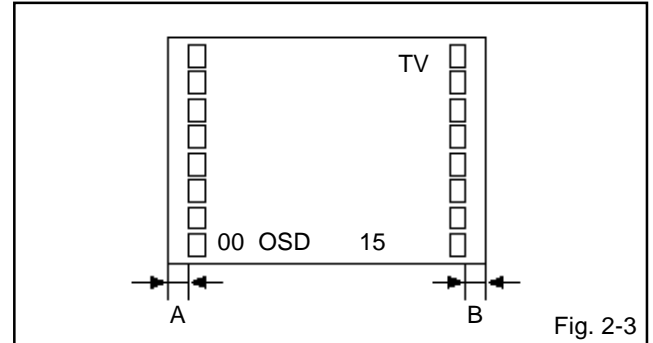

Fig. 2-3

2-10: VIF VCO

1. Place the set with Aging Test for more than 15 minutes.
2. Connect the digital voltmeter to **pin 5 of CP601**.
3. Activate the adjustment mode display of **Fig. 1-1** and press the channel button **(03)** on the remote control to select "VIF VCO".
4. Press the VOL. UP/DOWN button on the remote control until the digital voltmeter is 2.5V.

2-11: CONSTANT VOLTAGE

1. Using the remote control, set the brightness and contrast to normal position.
2. Connect the digital voltmeter to **TP401**.
3. Set condition is AV MODE without signal.
4. Adjust the **VR501** until the digital voltmeter is $130 \pm 1V$.

2-12: SEPARATION 1, 2

1. Receive the stereo broadcasting signal.
2. Connect the AC voltmeter to **AUDIO OUT JACK** through stereo filter (L=400Hz, R=2KHz).
3. Activate the adjustment mode display of **Fig. 1-1** and press the channel button **(20)** on the remote control to select "SEPARATION 1".
4. Press the VOL. UP/DOWN button on the remote control until the output of L-CH and R-CH become minimum.
5. Press the CH UP button once to set to "SEPARATION 2" mode.
6. Press the VOL. UP/DOWN button on the remote control until the output of L-CH and R-CH become minimum.

ELECTRICAL ADJUSTMENTS

3. PURITY AND CONVERGENCE ADJUSTMENTS

NOTE

1. Turn the unit on and let it warm up for at least 30 minutes before performing the following adjustments.
2. Place the CRT surface facing east or west to reduce the terrestrial magnetism.
3. Turn ON the unit and demagnetize with a Degauss Coil.

3-1: STATIC CONVERGENCE (ROUGH ADJUSTMENT)

1. Tighten the screw for the magnet. Refer to the adjusted CRT for the position. **(Refer to Fig. 3-1)**
If the deflection yoke and magnet are in one body, untighten the screw for the body.
2. Receive the green raster pattern from the color bar generator.
3. Slide the deflection yoke until it touches the funnel side of the CRT.
4. Adjust center of screen to green, with red and blue on the sides, using the pair of purity magnets.
5. Switch the color bar generator from the green raster pattern to the crosshatch pattern.
6. Combine red and blue of the 3 color crosshatch pattern on the center of the screen by adjusting the pair of 4 pole magnets.
7. Combine red/blue (magenta) and green by adjusting the pair of 6 pole magnets.
8. Adjust the crosshatch pattern to change to white by repeating steps 6 and 7.

3-2: PURITY

NOTE

Adjust after performing adjustments in section 3-1.

1. Receive the green raster pattern from color bar generator.
2. Adjust the pair of purity magnets to center the color on the screen.
Adjust the pair of purity magnets so the color at the ends are equally wide.
3. Move the deflection yoke backward (to neck side) slowly, and stop it at the position when the whole screen is green.
4. Confirm red and blue colors.
5. Adjust the slant of the deflection yoke while watching the screen, then tighten the fixing screw.

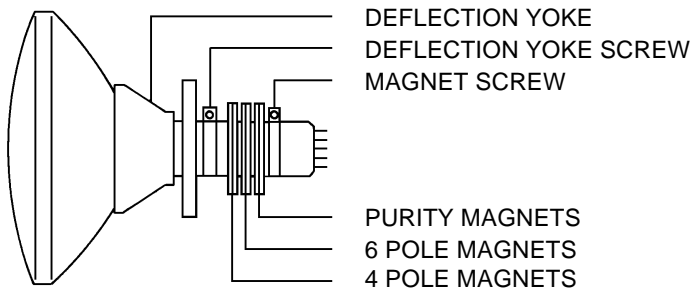

Fig. 3-1

3-3: STATIC CONVERGENCE

NOTE

Adjust after performing adjustments in section 3-2.

1. Receive the crosshatch pattern from the color bar generator.
2. Combine red and blue of the 3 color crosshatch pattern on the center of the screen by adjusting the pair of 4 pole magnets.
3. Combine red/blue (magenta) and green by adjusting the pair of 6 pole magnets.

3-4: DYNAMIC CONVERGENCE

NOTE

Adjust after performing adjustments in section 3-3.

1. Adjust the differences around the screen by moving the deflection yoke upward/downward and right/left. **(Refer to Fig. 3-2-a)**
2. Insert three wedges between the deflection yoke and CRT funnel to fix the deflection yoke. **(Refer to Fig. 3-2-b)**

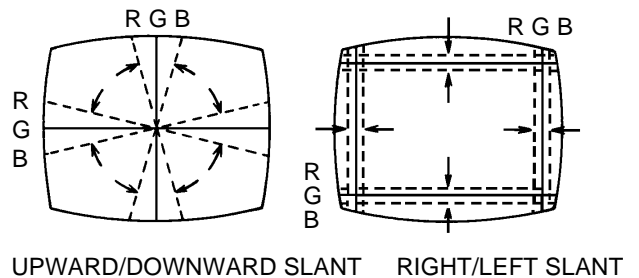

Fig. 3-2-a

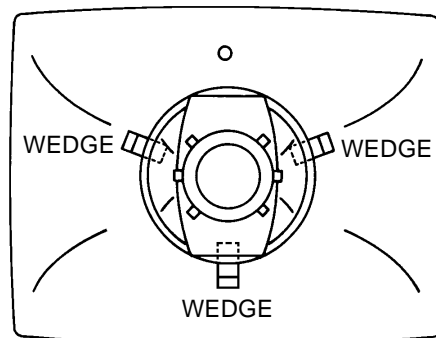
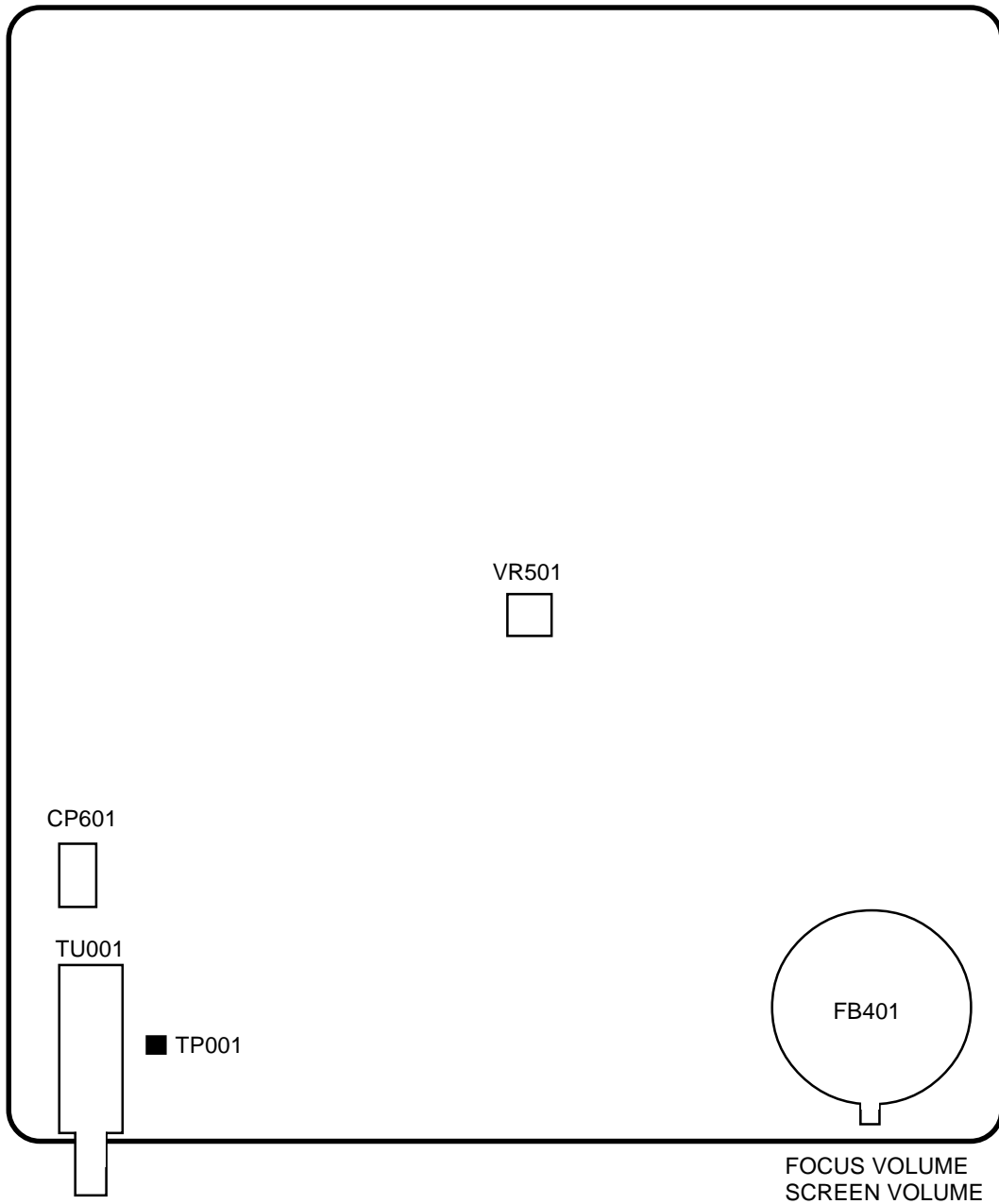
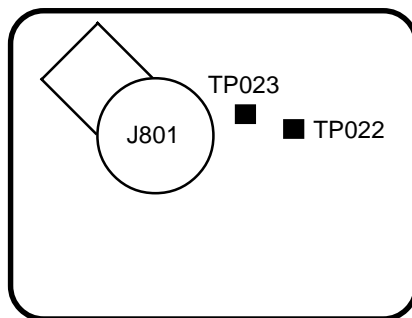

Fig. 3-2-b

MAJOR COMPONENTS LOCATION GUIDE



MAIN PCB



CRT PCB

BLOCK DIAGRAM

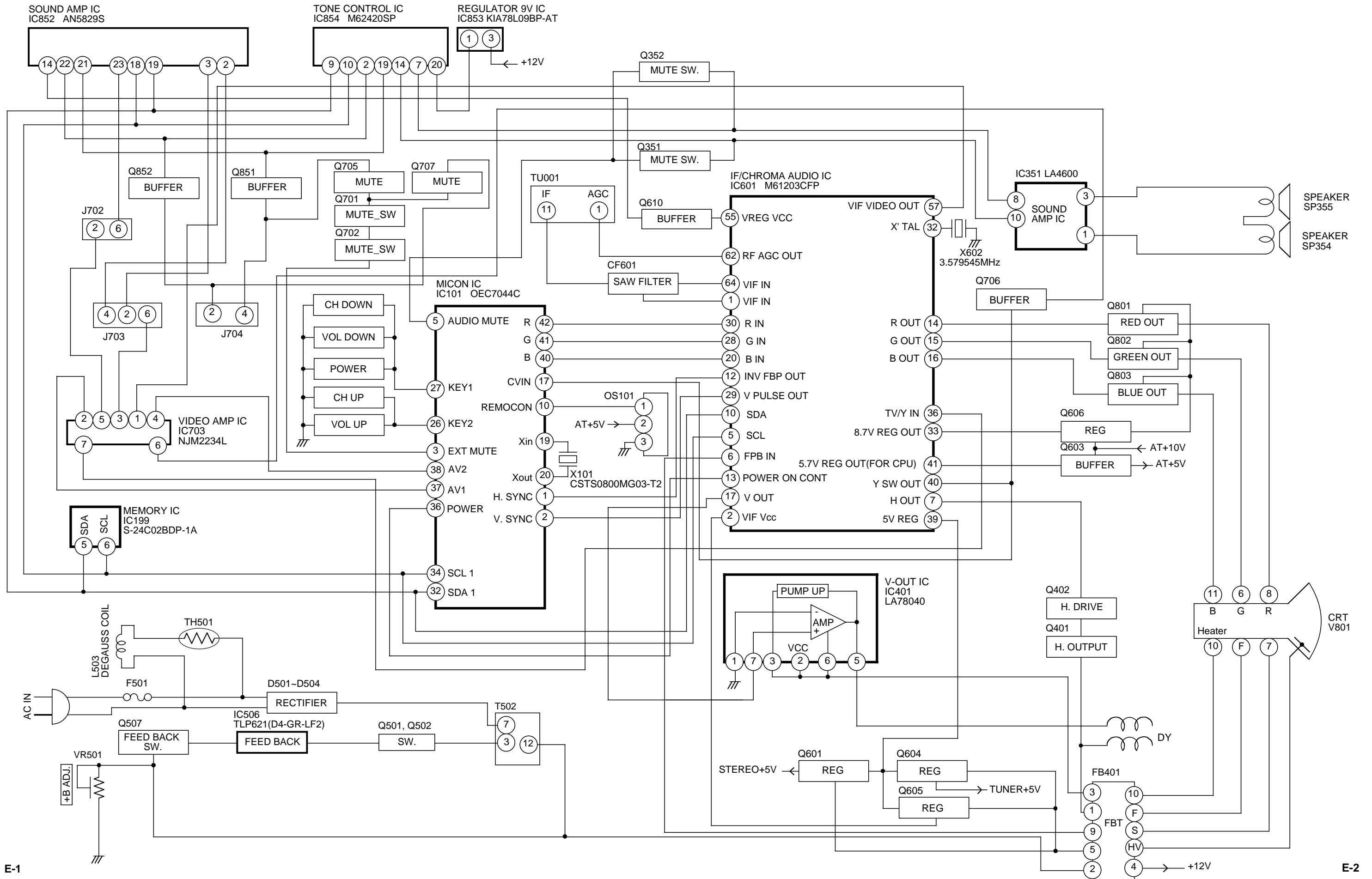

PRINTED CIRCUIT BOARDS

MAIN/CRT (INSERTED PARTS) SOLDER SIDE

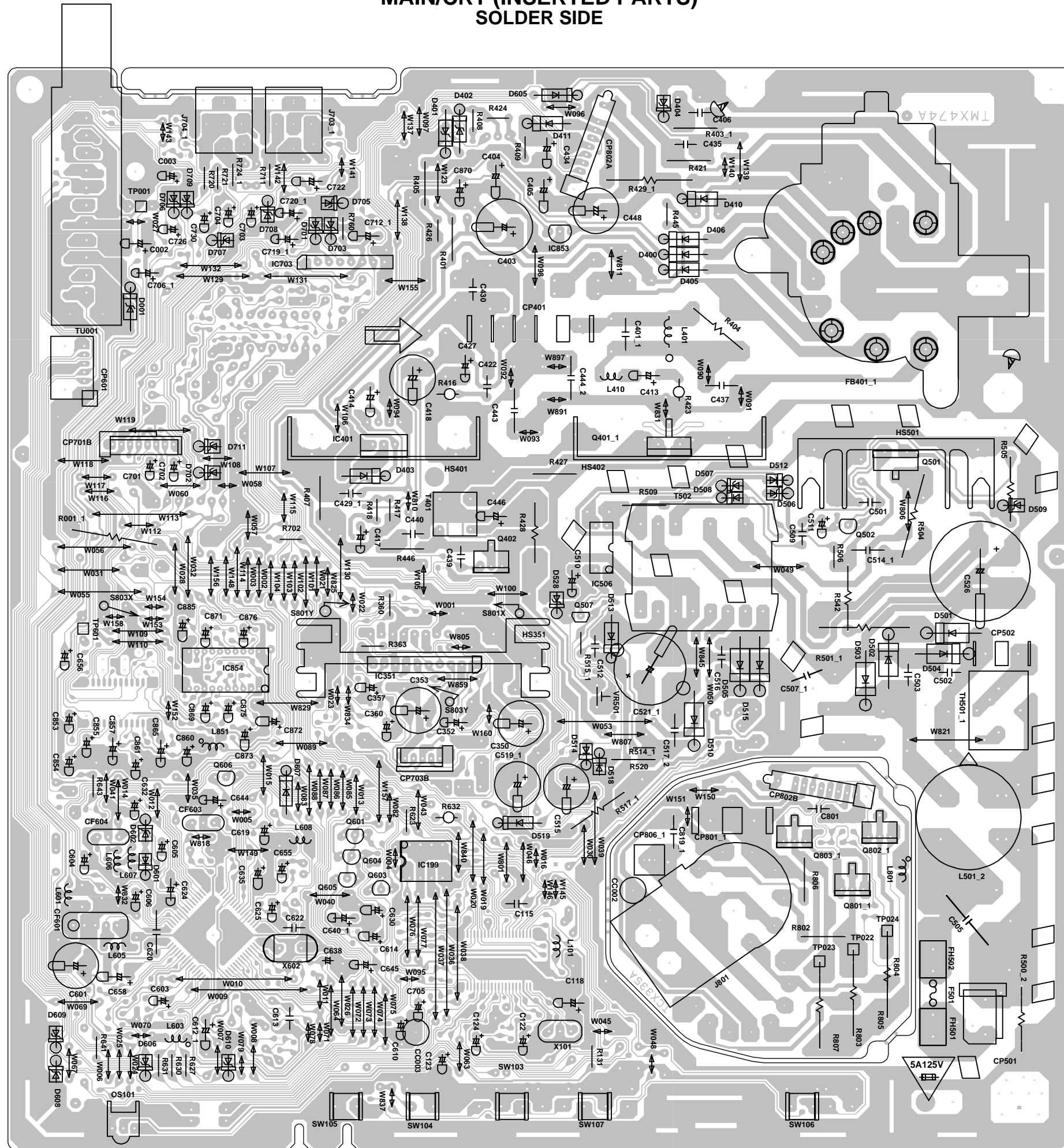

STEREO JACK SOLDER SIDE

